

Metric®-Cable Gland

tested acc. to DIN EN 62444, with metric connecting thread acc. to DIN EN 60423

350M50

EAN Code: 4011126369779

the photorealistic images are to be considered as reference images

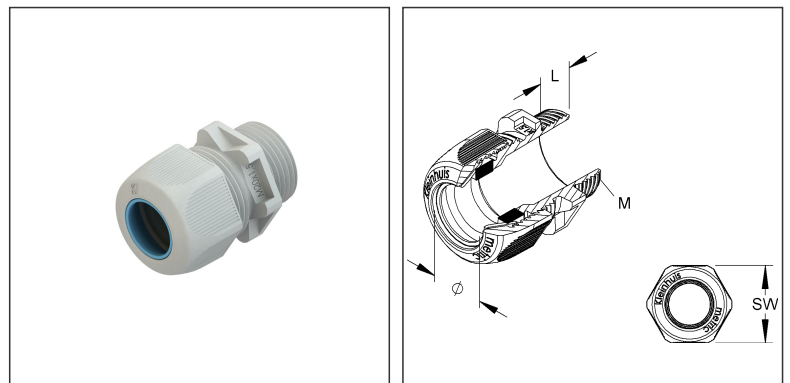

Article Description

Metric®-cable gland, M50, for cable-Ø 25-34 mm, Kunststoff PS, RAL 7035, lichtgrau

Additional Price Information

Article group	K104
---------------	------

Weight

Weight per quantity unit	61 g
Weight in kg per 100	6,03 kg

Physical Article Dimensions

Height	61.00 mm
Width	61.00 mm
Depth/length	62.00 mm
Diameter	61.00 mm

Technical Datasheet

Cable glands

350M50

the photorealistic images are to be considered as reference images

Packing Dimension

1 piece = 1 piece		✓ VP1-smallest packaging unit (PU)			
Lenght	62.00 mm	Width	61.00 mm	Height	61.00 mm
Gross weight	0,06 kg	Volume	0,000 m ³		
Min. quantity	1	Max. Quantity	1		
5 pieces = 1		✓ VP2-preferred PU			
Height	71.00 mm	Width	138.00 mm	Lenght	154.00 mm
Gross weight	0,36 kg	Volume	0,002 m ³		
Min. Quantity	5.00	Max. Quantity	5.00		
50 covering boxes = 1 piece					
Lenght	370 mm	Width	282 mm	Height	158.00 mm
Gross weight	3,87 kg	Volume	0,016 m ³		
Min. Quantity	50.00	Max. Quantity	50.00		

Tender Text

metric cable gland tested to DIN EN 62444, with metric connection thread to DIN EN 60423, halogen-free, connection thread sealing ring 987M...please order separately. Tightening of the cable gland is only recommended by hand!
 VDE certified!
 Nominal size : M 50
 for cable-Ø : 25 - 34 mm
 Connection thread length : 14 mm
 Width across flats : 55 mm
 Glow wire test acc. to DIN EN 60695-2-10+11/VDE 0471-2-10+11: 650°C
 Protection class : IP54
 Application temperature range : -30° to 60°C
 Gland body
 material : Polystyrene
 Sealing ring material : SBR/NBR Compression ring material : POM
 (polyoxymethylene)
 Colour : Light grey RAL: 7035 (similar)
 Kleinhuis Model-No. : 350M50 EP : 350M50
 EP Material_____ EP Wage_____
 Unit price/piece

Safety & Environment

REACH Date	23.01.2024
REACH Info	Conformable
RoHS Info	Conformable

Origin & International Trade

Country of origin	DE
Customs tariff number	39269097